

Article number: 021816011210

Description: Clamp with bracket and rubber
SPGU 6011. 210/30 SK

Measures

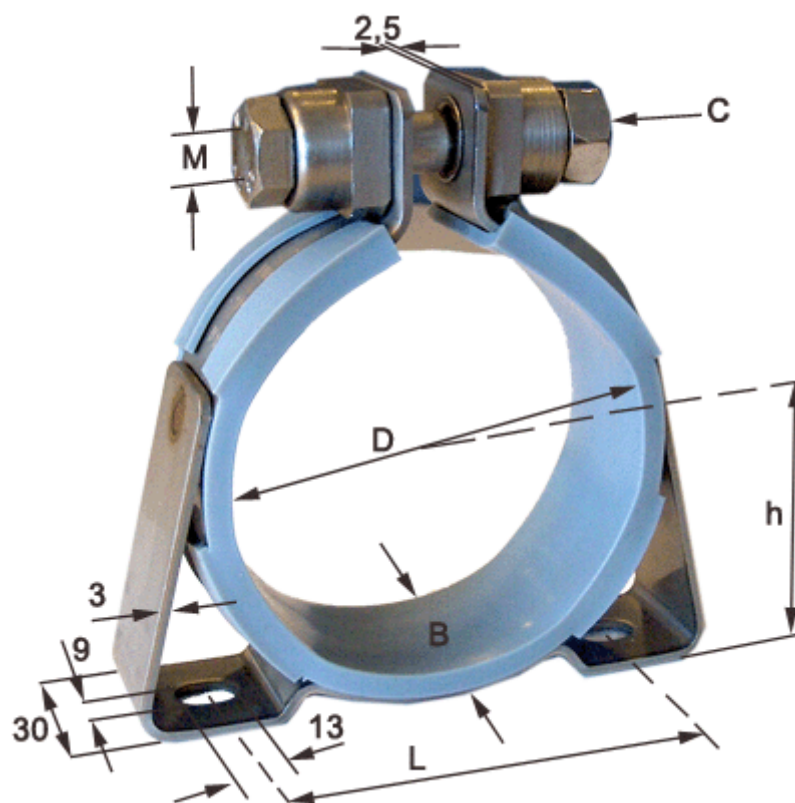

C (screw type) = SK hexagon screw

Diameter D = 210

h = 114

L = 212

Width B = 30